

Relay series SID

4-pole double armature relay with forcibly guided contact set according to IEC 61810-3

Product Launch November 2021

ELESTA GmbH

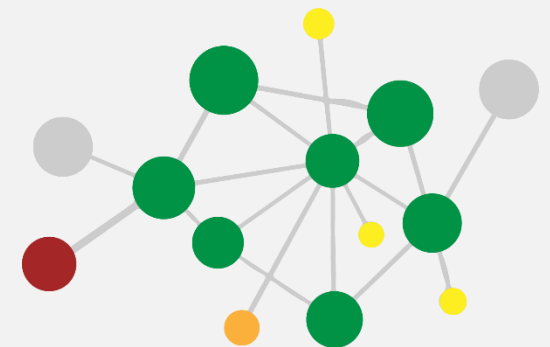

zusammen-wachsen

Relay series SID

Overview

- Introduction
- Structure
- Double armature
- Insulation coordination
- Advantages
- Assembly
- Functional safety
- Summary

Relay series SID

Introduction

Why is the SID relay an innovation in the field of relays with forcibly guided contact set according to IEC 61810-3?

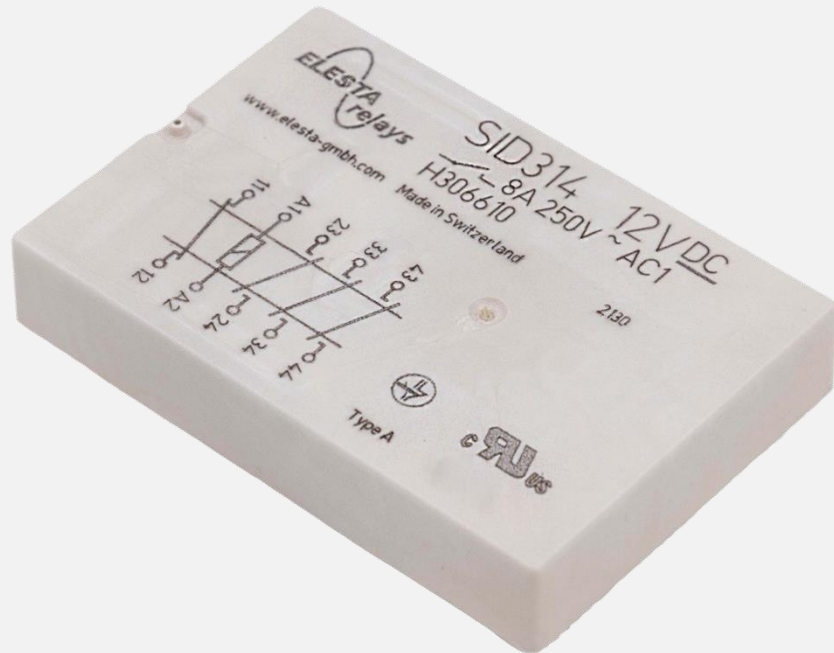

Picture: © ELESTA GmbH 2021

- A new approach for the realization of 2-channel safety controllers is possible
- The relays have two independent contact sets
- All specifications of forcible guiding according to IEC 61810-3 type A are fulfilled
- The relay drive has two independently acting solenoid armatures
- Environmentally friendly design

Relay series SID

Structure - mechanical 3D explosion drawing

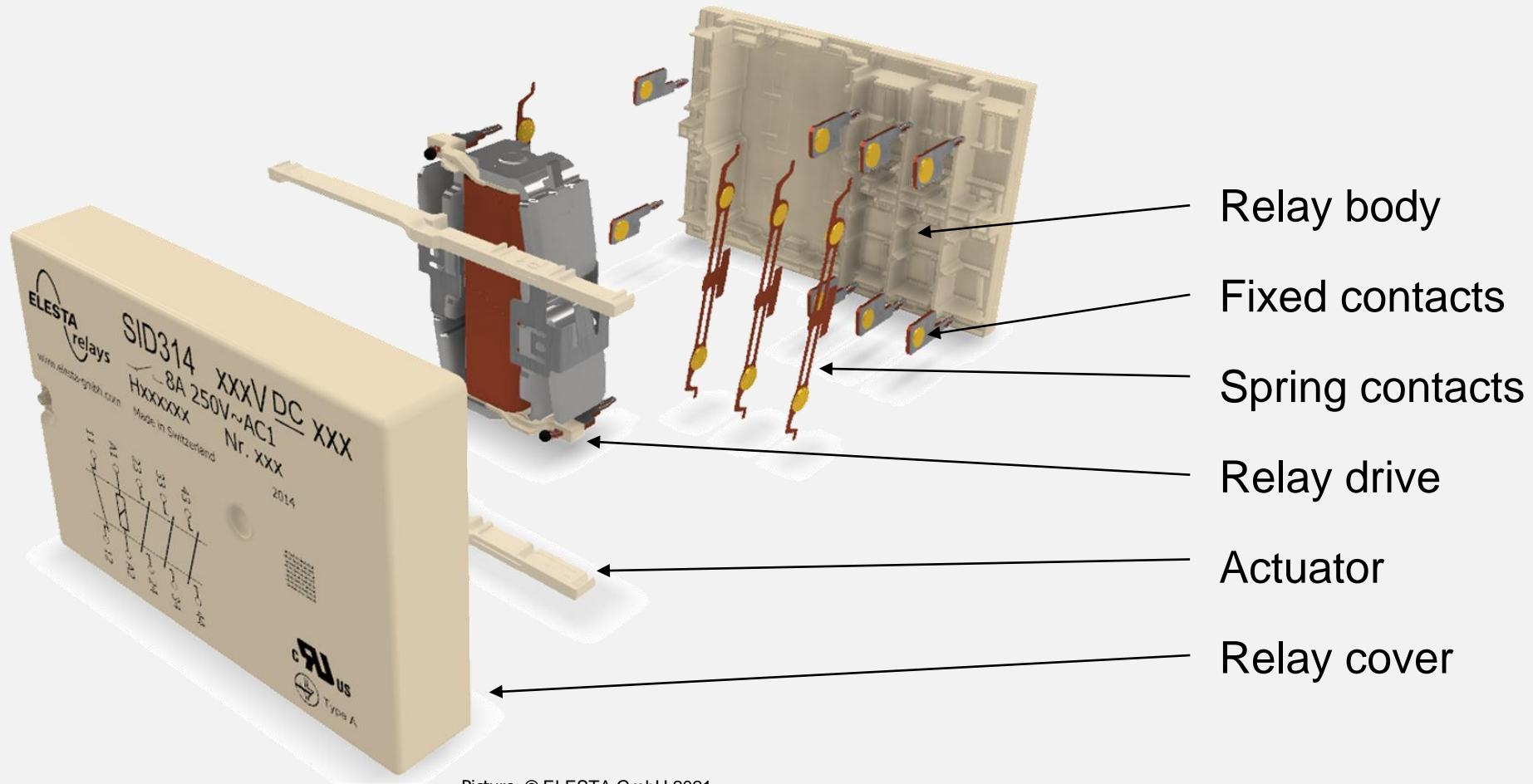

Picture: © ELESTA GmbH 2021

Relay series SID

Structure - SID312 On - Off

SID Basic position
(coil not energised)

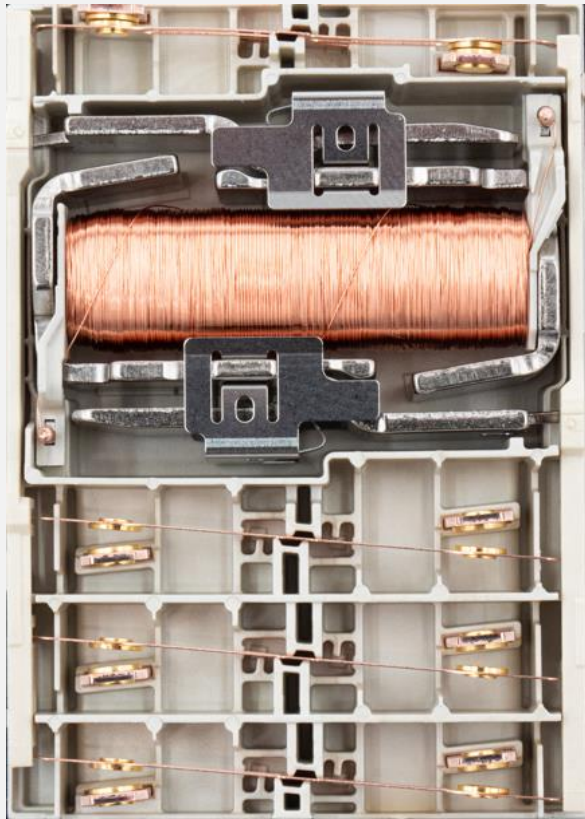

Picture: © ELESTA GmbH 2021

In default position

- Armatures do not rest on the yoke
- NC-contacts are closed
- NO-contacts are open

In working position

- Armatures lie against the yoke
- NC-contacts are opened
- NO-contacts are closed

SID Working position
(coil energized)

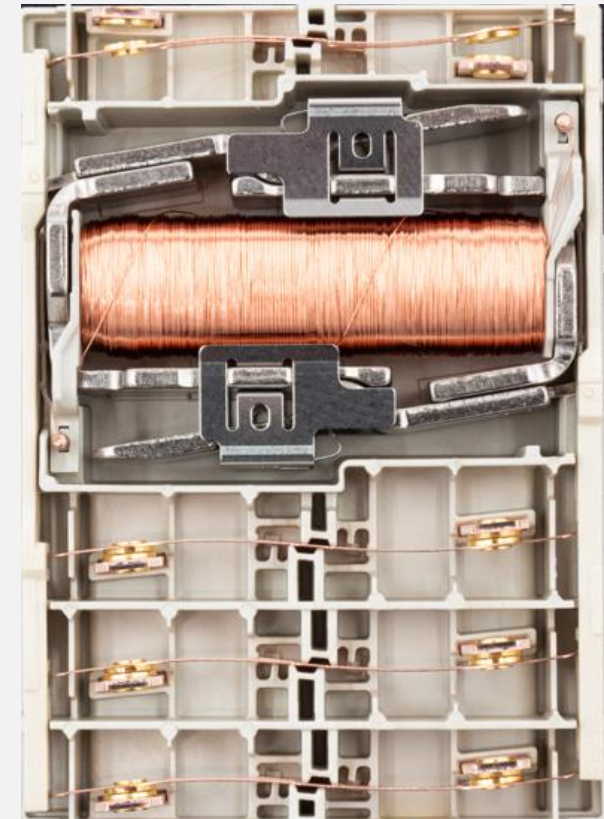

Picture: © ELESTA GmbH 2021

Relay series SID

Structure - SID312 basic position without relay cap

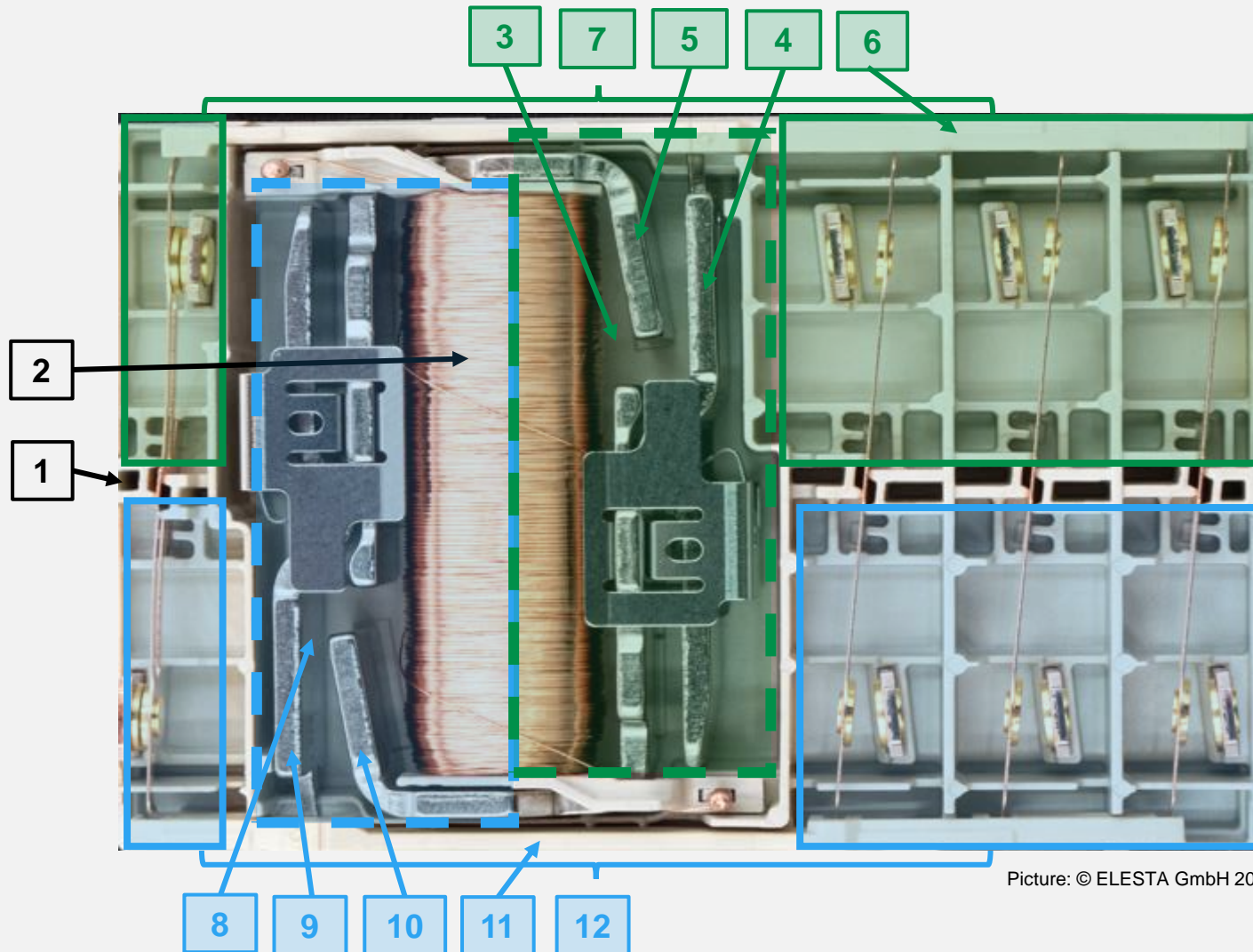

Picture: © ELESTA GmbH 2021

1. Base body
2. Coil
3. Magnetic circuit A
4. Armature A
5. Yoke A
6. Actuator A
7. Contact set A
8. Magnetic circuit B
9. Armature B
10. Yoke B
11. Actuator B
12. Contact set B

Relay series SID

Structure - SID312 neutral position without relay cap armature colored

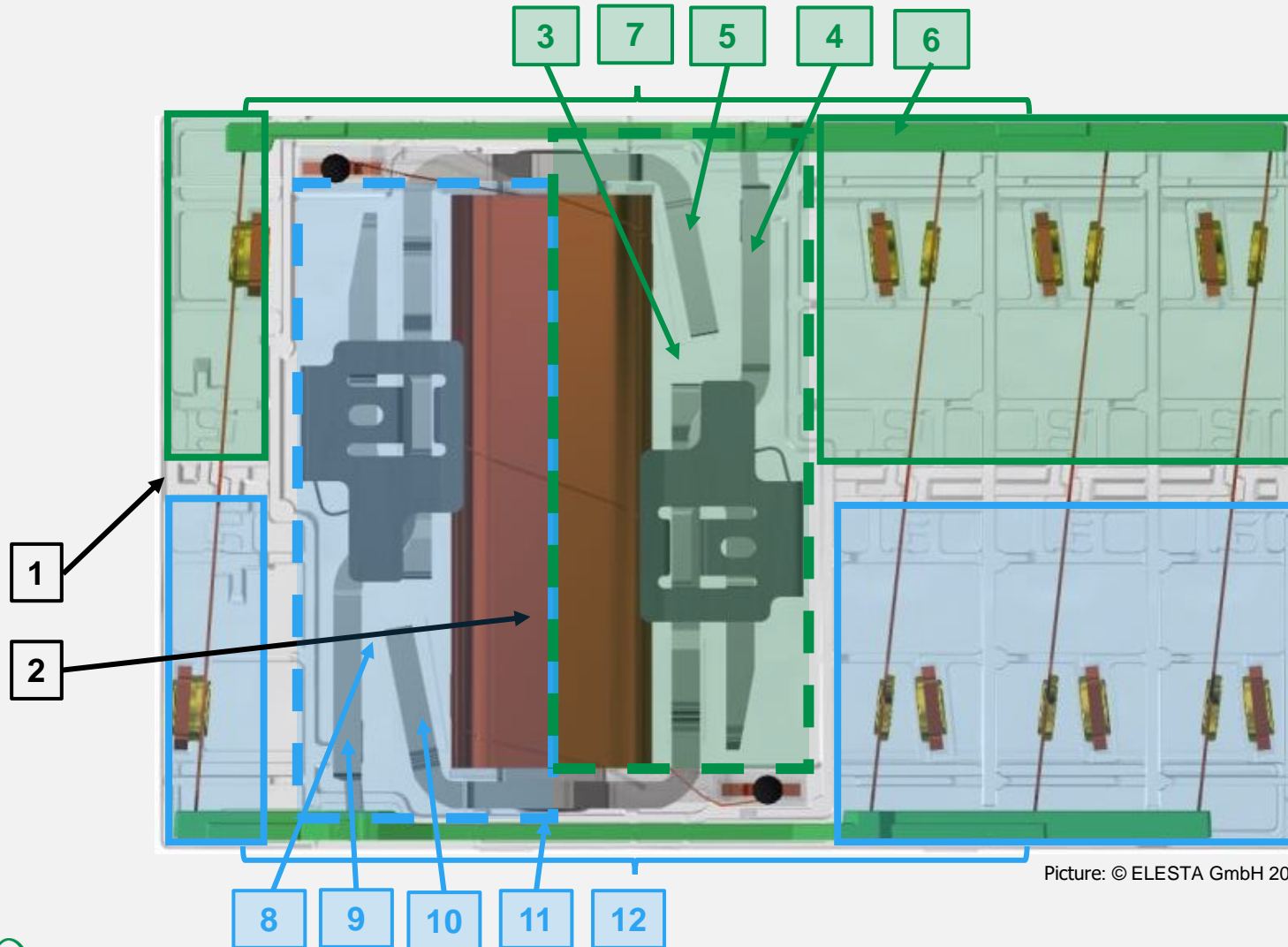

Picture: © ELESTA GmbH 2021

1. Base body
2. Coil
3. Magnetic circuit A
4. Armature A
5. Yoke A
6. Actuator A
7. Contact set A
8. Magnetic circuit B
9. Armature B
10. Yoke B
11. Actuator B
12. Contact set B

Relays Series SID

Structure - SID312 behavior at failure to open

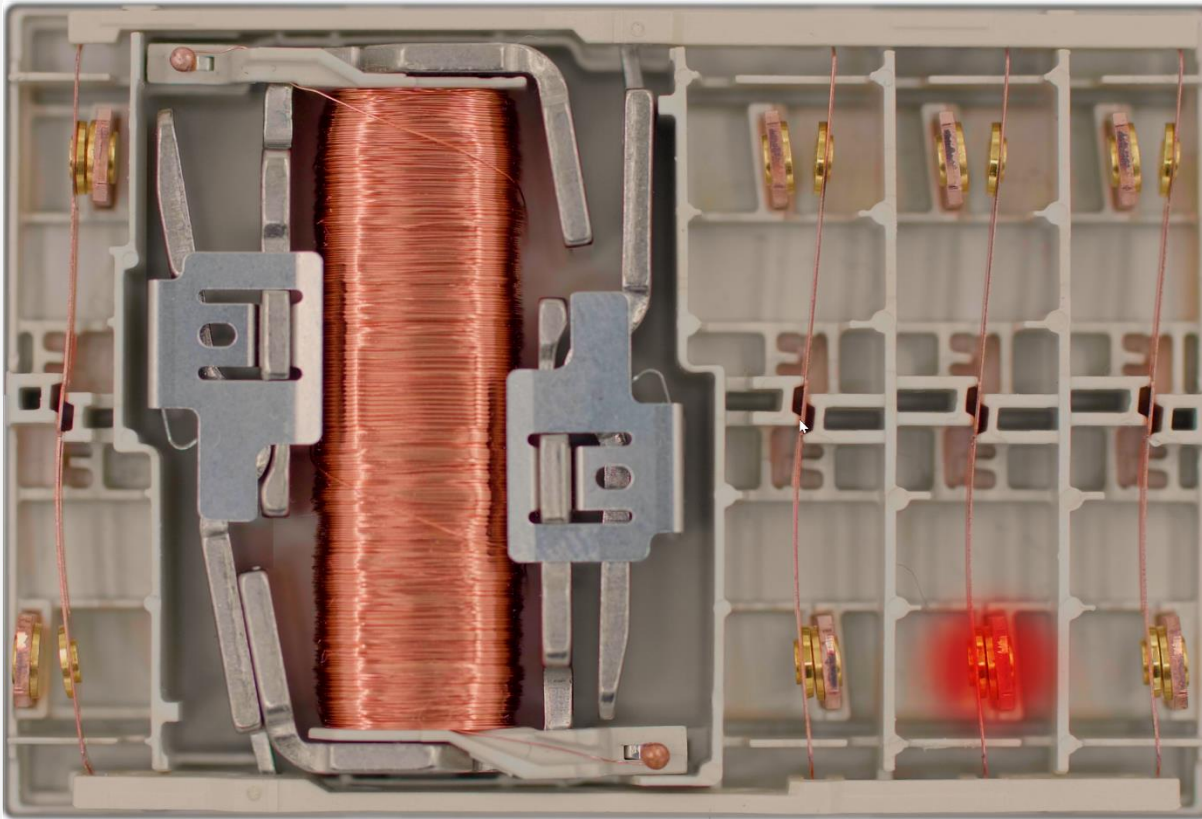

1. **Relay in neutral state**
2. **Coil energized**
 - 1NO of contact set A is welded
3. **Coil switched off**
 - 1NO of contact set A is blocked
 - Fall back of NC at contact set A is blocked
 - Contact set B falls back to default position
4. **Relay in neutral state**
5. **Coil energized**
 - 1NO of contact set B is welded
6. **Coil switched off**
 - 1NO of contact set B is blocked
 - Fall back of NC at contact set B is blocked
 - Contact set A falls back to default position

Relay series SID

Double armature - special features for relays according to IEC 61810-3

Relay drive
Relay series SID4

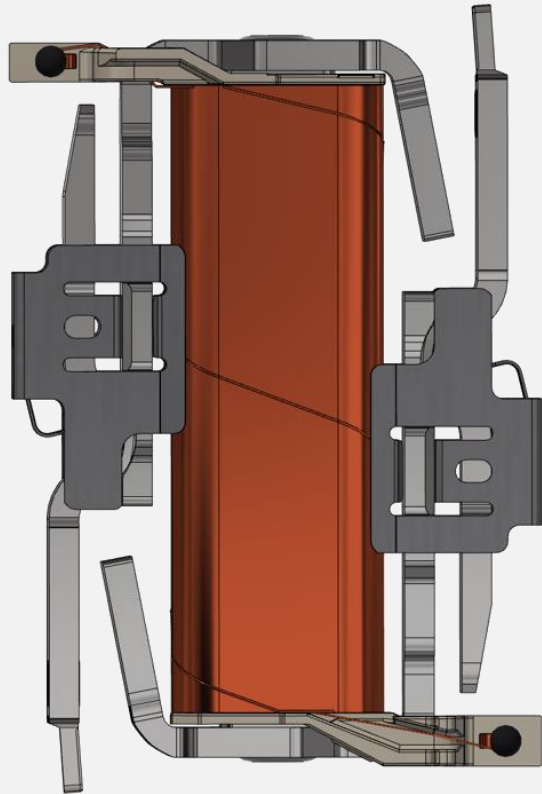

Picture: © ELESTA GmbH 2021

Requirements for the double armature and contact set are:

- The contact sets are independently driven
- Each of the armatures performs comparably to a conventional monostable relay
- The response and release times behave to each other like those of two independently operating relays to each other
- Design specifications for relays with forcibly guided contacts, require higher magnetic force compared to "standard relays" The reasons are the following:
 - Opening width in the disturbed state (failure to open) of the counter-functional contacts of 0.5 mm (single contact)
 - Relay release at 10% of the nominal coil voltage

Relay series SID

Double armature - structure and magnetic flux modeling

Mechanical structure

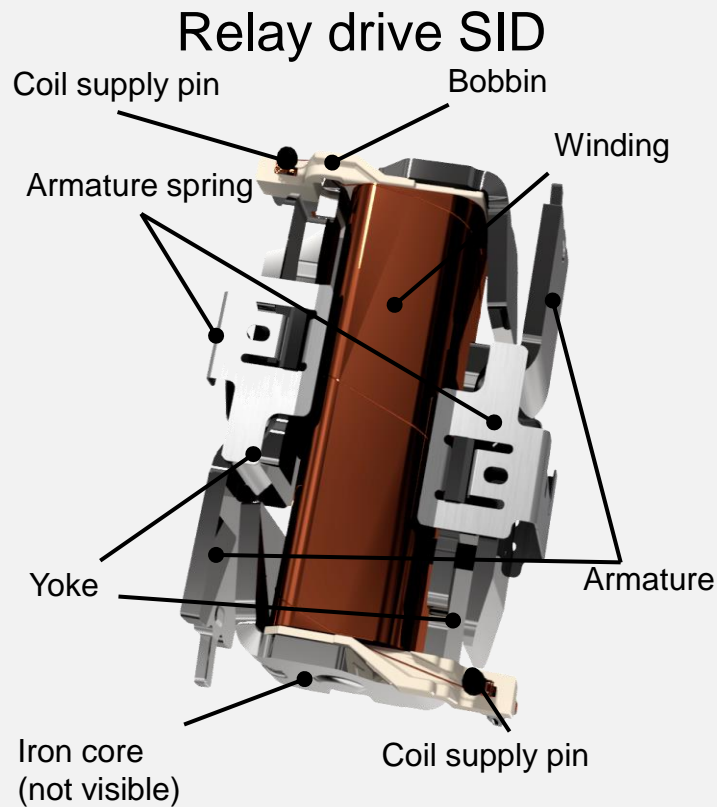

Picture: © ELESTA GmbH 2021

Relay drive in detail

- Bobbin with one winding excites both magnetic circuits
- Armatures are driven independently of each other by the magnetic flux
- Magnetic flux of both magnetic circuits pass through the common coil core
- Armatures close and open independently

Magnetic flux modeling Relay drive SID

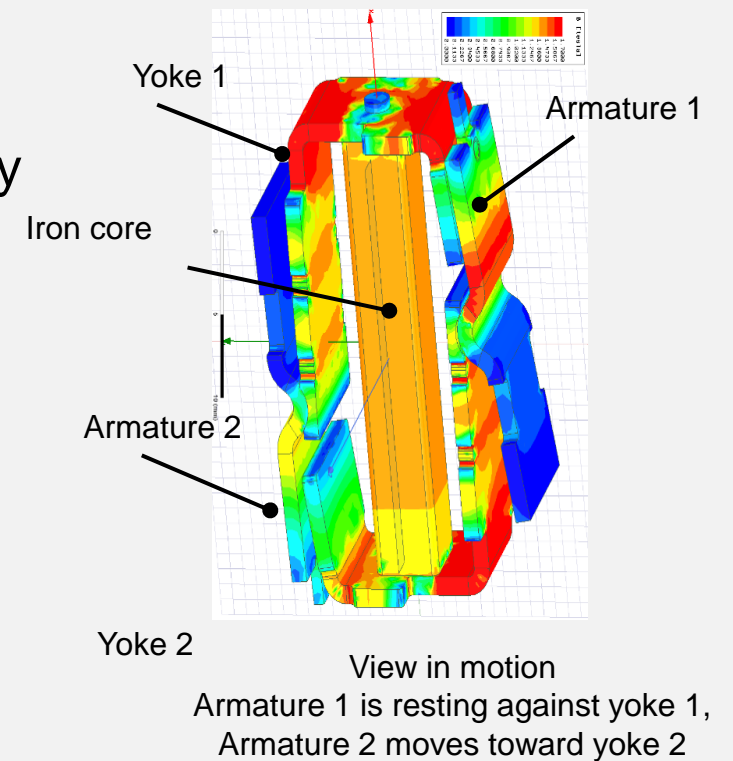

Picture: © ELESTA GmbH 2021

Relay series SID

Switching contacts - contact springs and fixed contacts

1NO contact of contact set A and B (functional top view)
1NO contact of contact set A and B (disassembled)

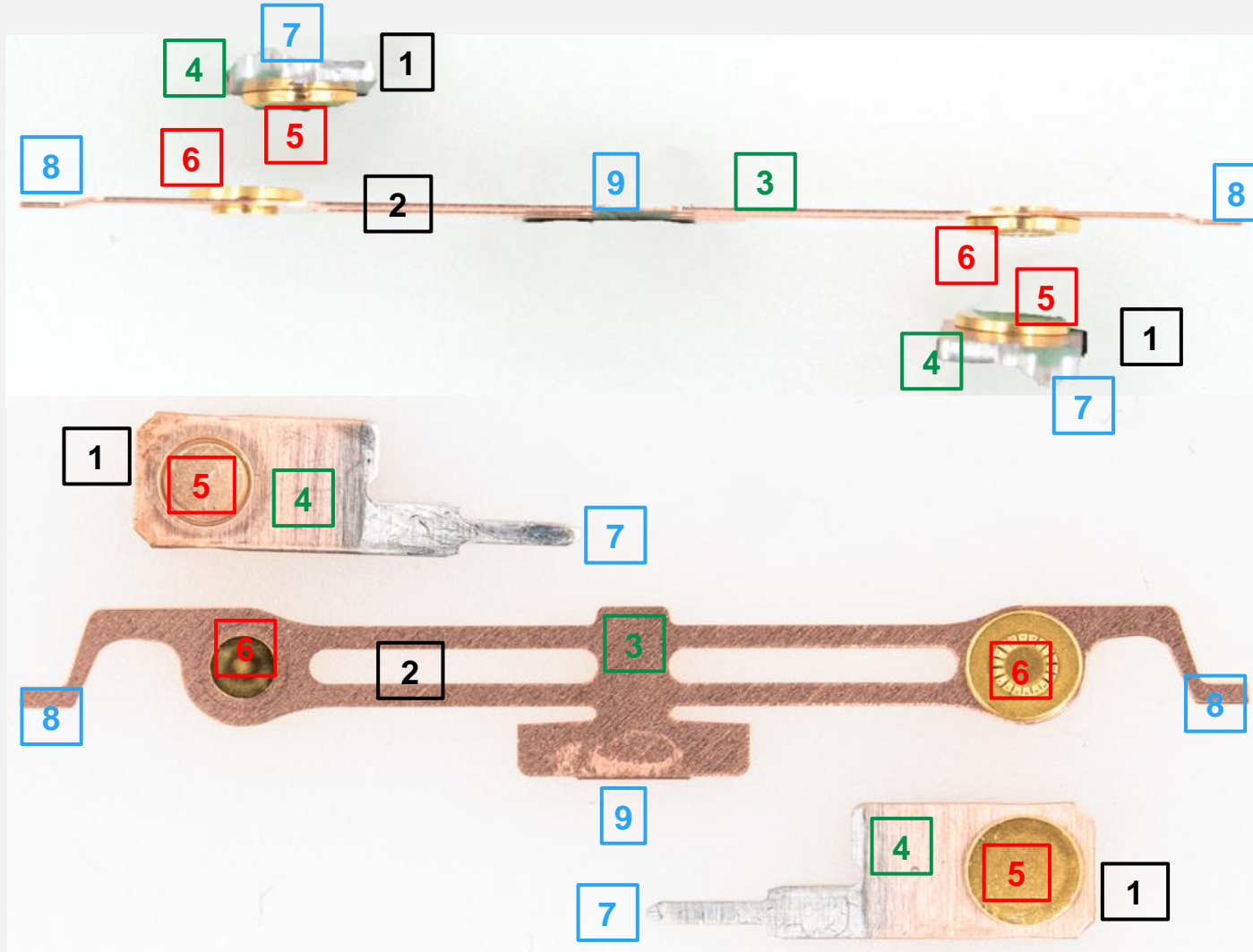

1. Fixed contact
2. Spring contact
3. Contact spring
4. Fixed contact carrier
5. Contact rivet: single contact
6. Contact rivet: lobe crown contact
7. Solder connection
8. Actuator mounting
9. Contact spring mounting
Contact set A to B

Relay series SID

Switching contacts - contact chambers / contact sets



Feedback contacts NC

Load contacts NO

- Spatial separation between feedback circuits and load circuits
- Separation between contact chambers contact set A to contact set B
- Shielding to armature A and armature B
- Accommodation of the common contact spring of contacts set A and contact set B

Picture: © ELESTA GmbH 2021

Relay series SID

Switching contacts - contact loads

Contact data

Contact material	AgSnO ₂ + 0,2, ..., 0,4 μm Au
Type of contact	Single contact with notched crown
Rated switching power	2000 VA
250 V / 8 A / AC-1 (max.)	
Electr. life time (0,1 Hz, rel. duty cycle 10%)	100 000
Inrush current	30 A for 20 ms
Switching voltage range	5, ..., 250 V DC / AC
Switching current range*	3 mA, ..., 8 A
Switching power range*	40 mW, ..., 2000 W (VA)
Contact resistance as new (max.)	100 mΩ
Short circuit resistance of NO contacts**	1000 A
with pre-fuse	SCPD 10 A gG / gL (fuse)
Short circuit resistance of NC contacts**	1000 A
with pre-fuse	SCPD 6 A gG / gL (fuse)

* Reference values ** Prospective short-circuit current

Picture: © ELESTA GmbH 2021

Switching load ranges

- Extremely wide load range from 3mA to 8A
- Max. Switching current for 2 load contacts each 8A
- Max. Switching current for 3 load contacts each 6A
- Inrush currents up to 30A for 20ms
- Customized coil voltages possible
- High switching reliability due to lobe crown contact for small switching loads

Electrical life (NO contacts)

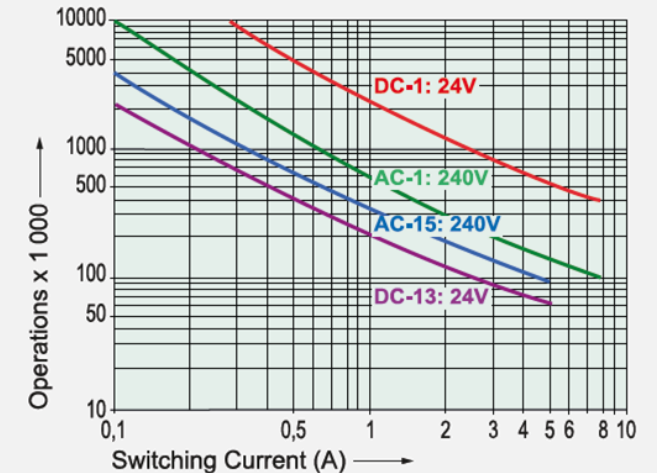

Switching capacity (IEC 61810-1)

AC-1:	240 V / 8 A MAX
AC-15:	240 V / 5 A MAX
DC-1:	24 V / 8 A MAX
DC-13:	24 V / 5 A / 0,1 Hz MAX
	L/R = 40ms

Switching capacity (UL 508)

	B300, R300
Continuous current per contact at load of:	
1 or 2 contacts	8 A MAX
3 contacts	6 A MAX

Picture: © ELESTA GmbH 2021

Relay series SID

Advantages - energy saving

Energy saving with SID 4-pole compared to 2 SIF 4-pole

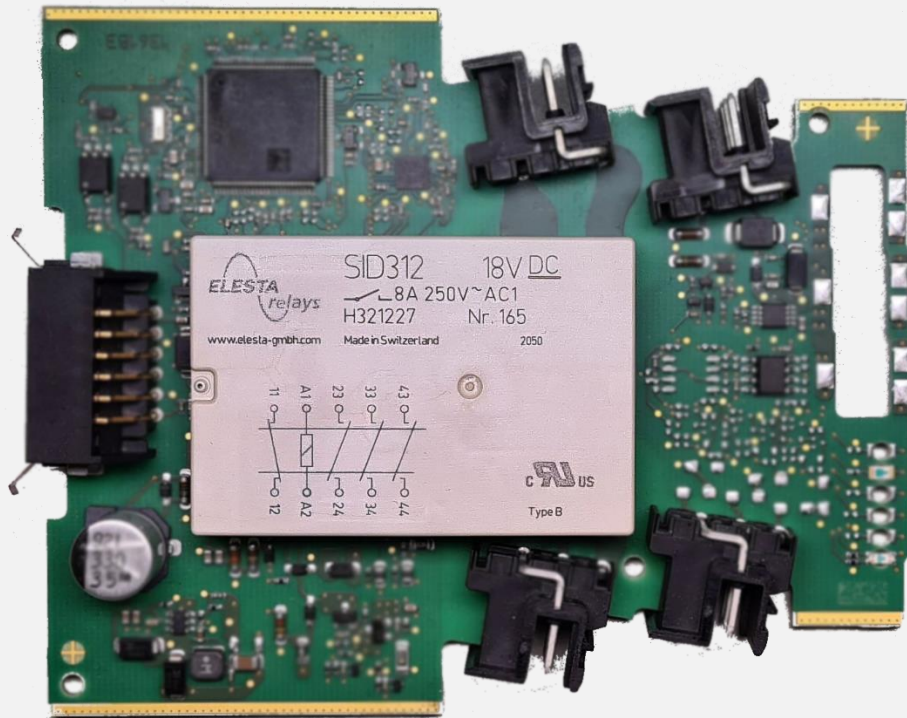

Picture: © ELESTA GmbH 2021

Energy saving with SID 4-pole

- Coil power rating per SIF 4-pole ~ 700 mW
- Coil nominal power with 2 SIF 4-pole ~ 1400 mW
- Coil power with 1 SID 4-pole ~ 820 mW
- Savings in nominal coil power 580 mW (41%)
- Holding power per SIF 4-pole ~ 210 mW
- Holding power with 2 SIF 4-pole ~ 420 mW
- Holding power with 1 SID 4-pole ~ 250 mW
- Saving holding power 170 mW (41%)

Relay series SID

Advantages - material saving

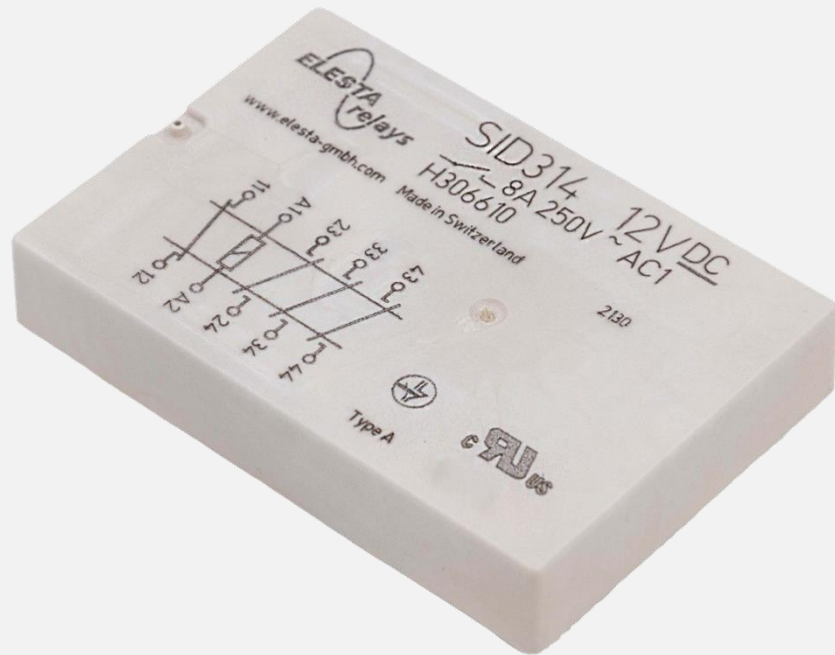

Picture: © ELESTA GmbH 2021

SID312 weight reduction compared to 2 SIF312

- Weight 2 x SIF 312 ~ 38.6 g
- Weight 1 x SID 312 ~ 33.6 g
- Weight reduction 6.4 g
- ~ 13% weight reduction

The weight reduction is composed as follows:

- minus ~ 39% plastic saving
- plus ~ 17% magnetic soft iron rFe

Relay series SID

Advantages - space requirement

Setup with 2 relays SIF 312

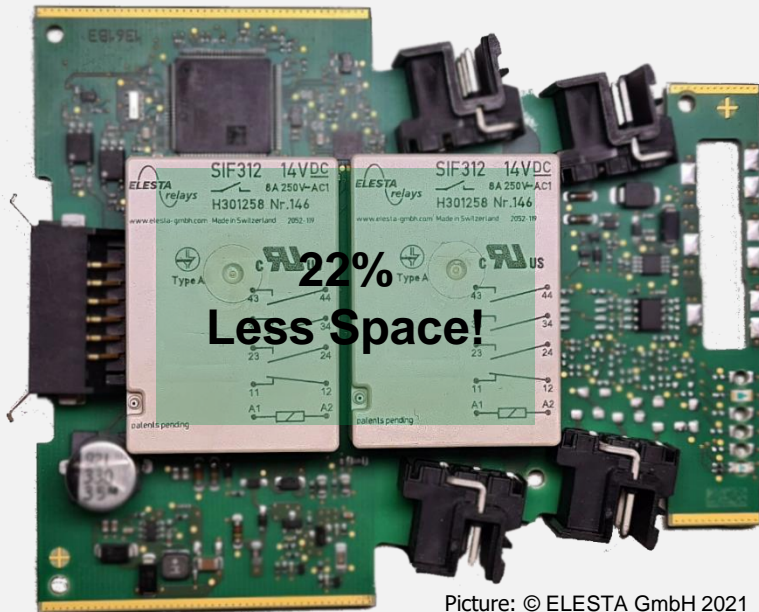

Space requirement

- Space requirement 2 x SIF 312 with mounting distance ~ 2452 mm²
- Space requirement 1 x SID 312 with mounting distance ~ 1908 mm²
- Space saving ~ 544 mm²
- **22% Space reduction!**

Setup with 1 relay SID 312

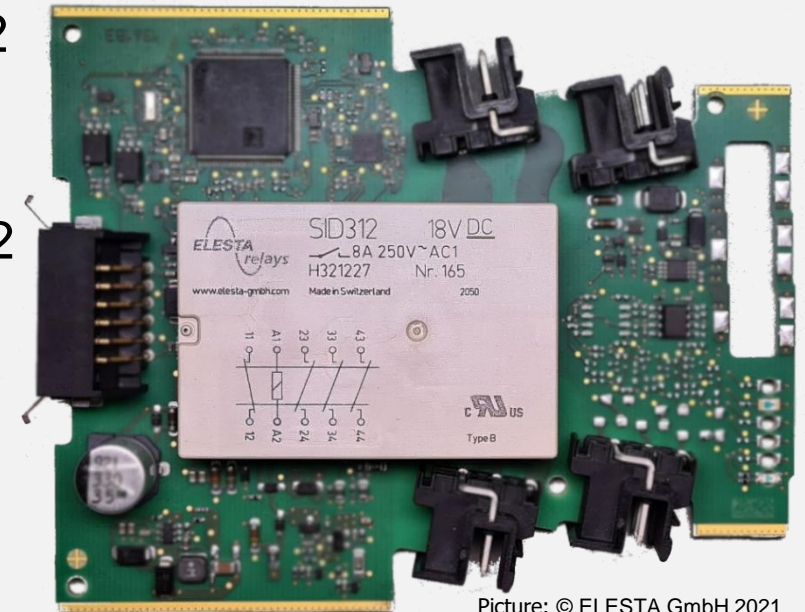

Relay series SID

Advantages - Compact design

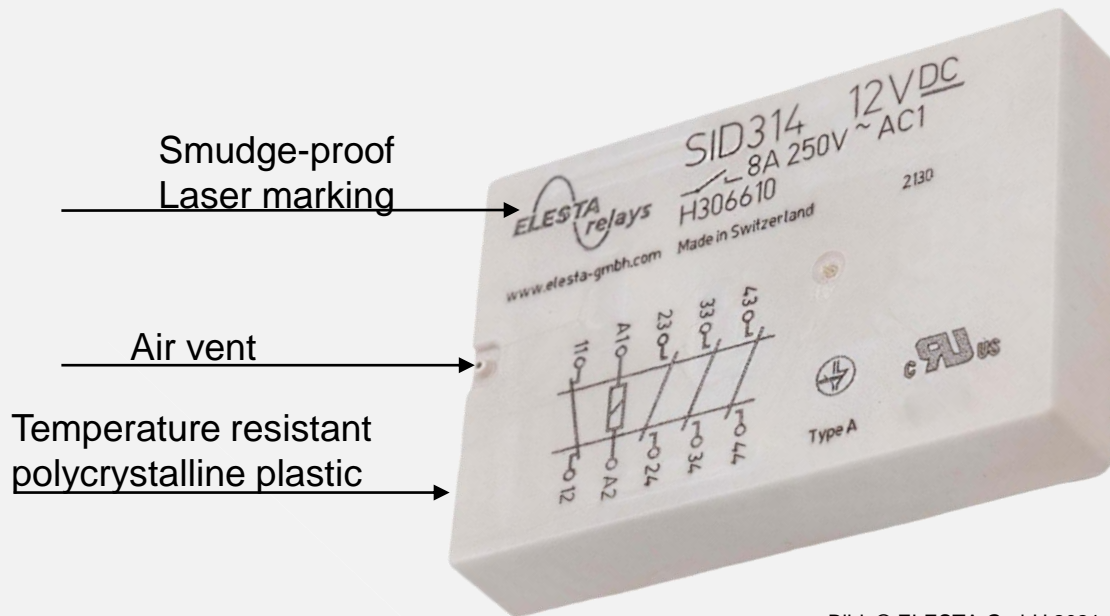

Features

- Relay with forcibly guided contacts according to IEC 61810-3
- Application type A
- Protective separation (see insulation data)
- Suitable for print mounting
 - With solder connections
 - With ELO pins for press-fit technology
- Double armature relay with 2 contacts in series per path
- Dual-channel capability with only one relay possible
- SMD placement under the relay possible
- Height only 10,9 mm
- Contact assembly
SID312/SID314: 3 NO + 1 NC

Bild: © ELESTA GmbH 2021

Relay series SID

Assembly - advantages layout

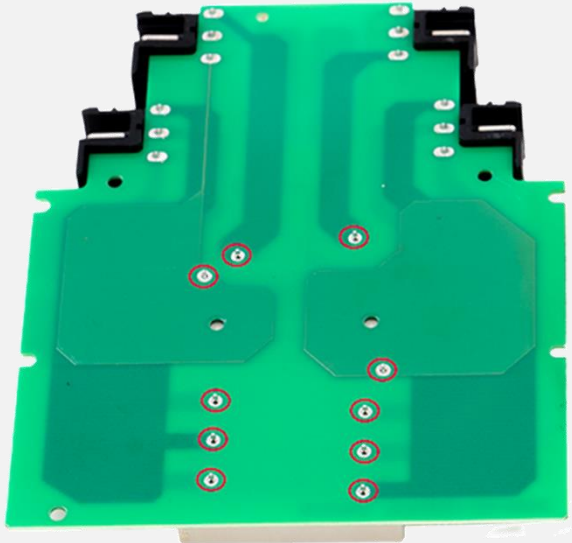

Picture: © ELESTA GmbH 2021

10 drill holes for SID312

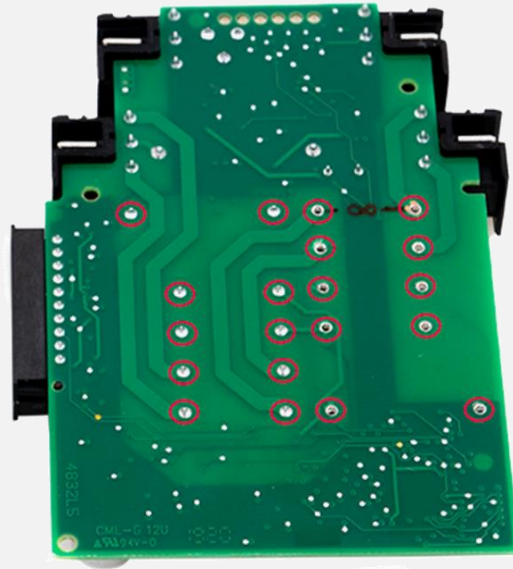

Picture: © ELESTA GmbH 2021

20 drill holes for 2 pieces SIF312

Layout Benefit

- Reduction of drilling from 20 holes to 10 holes
- Savings of 50% of the drillings
- Less layout effort
- Higher design reliability of the board

Relay series SID

Advantages - component placement under the housing



Bild: © ELESTA GmbH 2021



Bild: © ELESTA GmbH 2021



Bild: © ELESTA GmbH 2021

- Additional placement area of 360 mm² for SMD components
- Additional placement area of components up to approx. 3 mm height

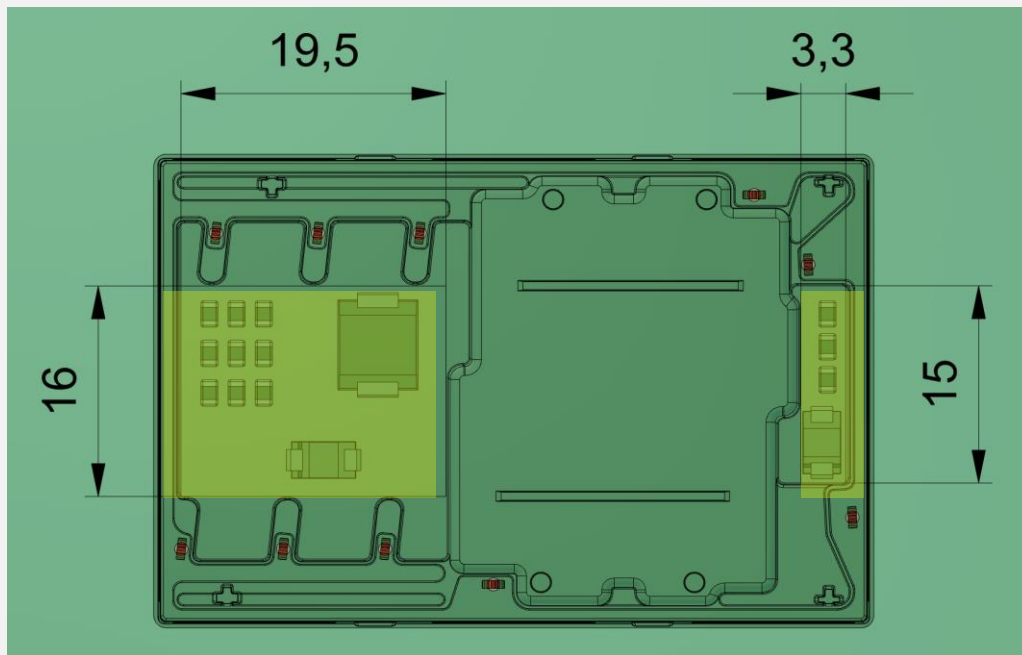
Relay series SID

Assembly - Wave soldering, selective soldering, manual soldering

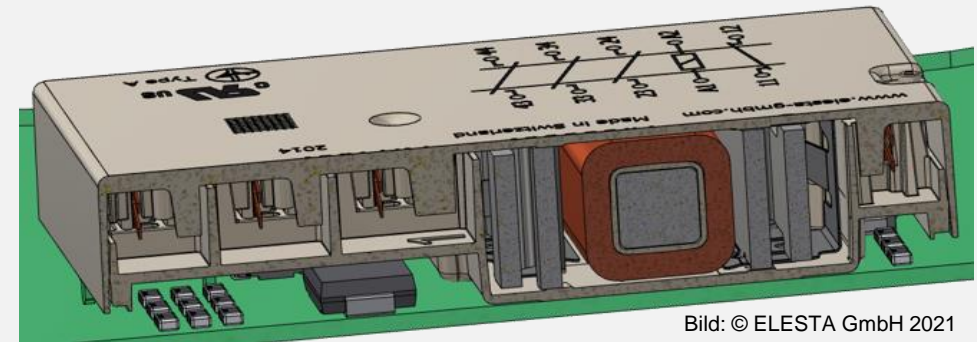
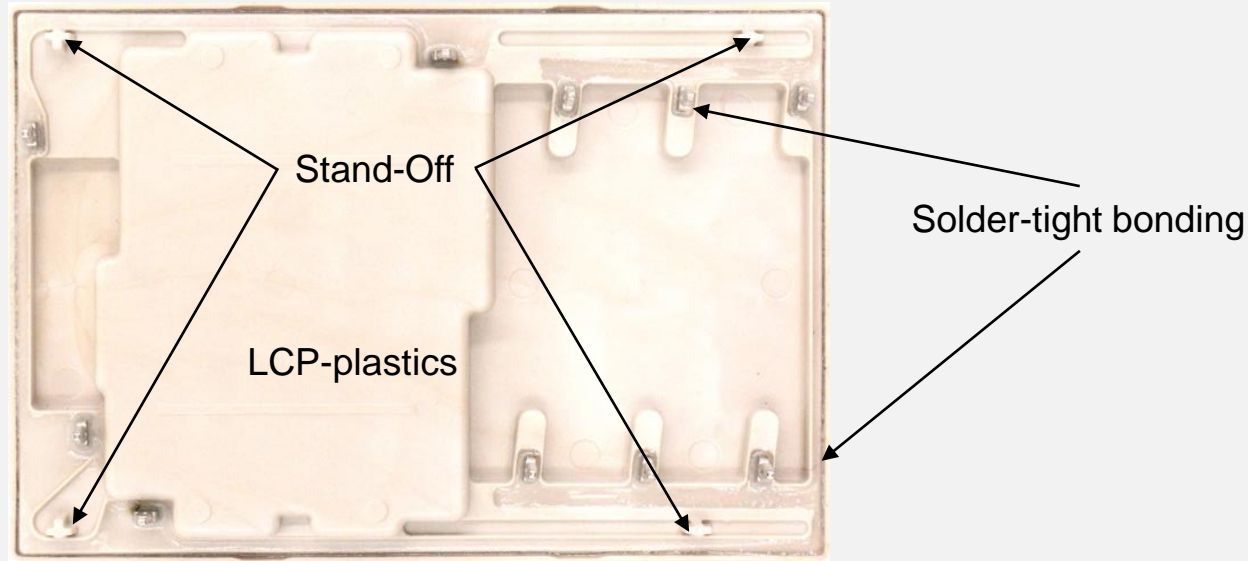

Picture: © ELESTA GmbH 2021

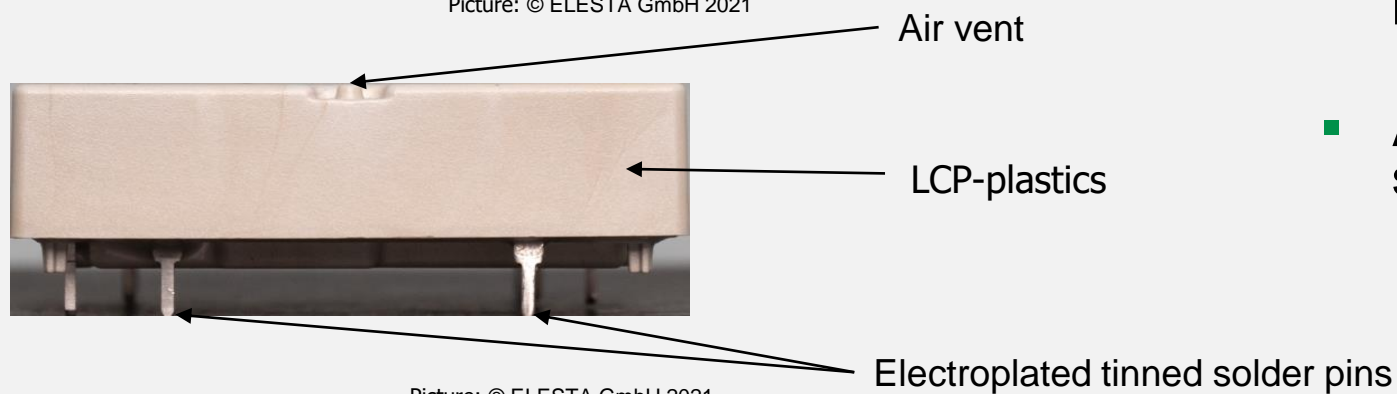

Picture: © ELESTA GmbH 2021

- Flux-tight base body
- Stand-off for distance definition
- Tin-plated print pins
- Ventilation prevents thermal stress in the soldering process
- All plastic parts made of thermally stable LCP plastics

Relay series SID

Assembly - ELOPIN - Introduction

ELOPIN in relay base body



Picture: © ELESTA GmbH 2021

- ELOPIN is a patented press-fit pin that connects the SID relay to the board instead of a solder pin.
- This eliminates the soldering process in the manufacture of the control board

Relay series SID

Assembly - ELOPIN (press-fit technology) - Introduction

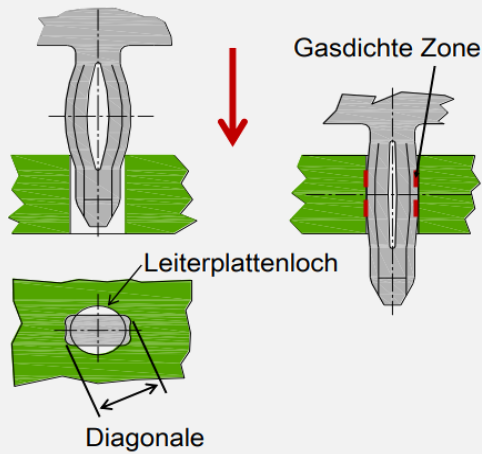

Picture: © EPC-Schulung-070912-01-01

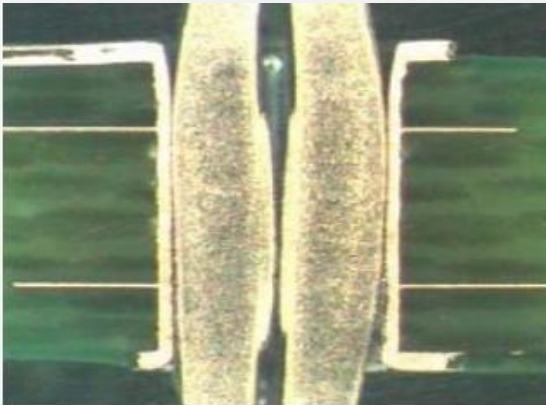

Picture: © EPC-Schulung-070912-01-01

Elastic press-fit pin for solderless electrical connections

The concept

- The press-fit contact has a larger diagonal than the PCB hole
- High contact forces are created at the deformed points, resulting in a gas-tight zone and a low-resistance electrical connection
- Plastic and elastic deformation occurs

Advantages of press-fit technology

- Cost-effective double-sided assembly of printed circuit boards
- No problems due to solder bridges, flux residues, bad solder joints and thermal stress
- No environmentally harmful substances.
- Use with lead-free and halogen-free printed circuit boards

Profitability

- Usually cheaper compared to soldering technology
- No expensive plastics for SMT because of the high temperatures, especially with lead-free tin solders
- No quality problems with SMT solder joints due to deflection and conductor lift-off

Relay series SID

Assembly - ELOPIN (press-fit technology) - Introduction

Reliability Comparison of connection technologies

Verfahren	Leiterquerschnitt in mm ²	Ausfallrate λ_{ref} in FIT ¹⁾	Hinweise: Normen/Richtlinien
Löten manuell maschinell	-	0,5 0,03	IPC 610 ²⁾ , Klasse 2
Wirebonden für Hybridschaltungen Al Au		0,1 0,1	28 µm / Wetch – Bond 25 µm / Ball – Bond
Wickeln	0,05 bis 0,5	0,002	DIN EN 60352 – 1 / IEC 60352 – 1 CORR1
Crimpen manuell maschinell	0,05 bis 300	0,25	DIN EN 60352 – 2 / IEC 60352 – 2 A 1+2
Klammern	0,1 bis 0,5	0,02	DIN 41611 – 4
Einpressen	0,3 bis 2	0,005	IEC 60352 – 5
Schneid-Klemmen	0,05 bis 1	0,25	IEC 60352 – 3 / IEC 60352 – 4
Schrauben	0,5 bis 16	0,5	DIN EN 60999 – 1
Klemmen (Federkraft)	0,5 bis 16	0,5	DIN EN 60999 – 1

1) 1 FIT = 1×10^{-9} 1/h ; (Ein Ausfall pro 10^9 Bauelementestunden)
2) Annahmebedingungen für gedruckte Schaltungen

Tabelle 3 Ausfallraten verschiedener Verbindungstechnologien
Siemens Norm SN 29500-5 / Edition 2004-06 Part 5

Picture: © EPC-Schulung-070912-01-01

ELOPIN reliability evaluation

- After wire wrap, the lowest failure rate
- Gas-tight connection without bow waves, nozzle effect or planing (corrosion resistance)
- High elasticity of the connection in case of shock, vibration and temperature fluctuations
- Suitable for "heavy components" due to high holding forces
- Low press-in forces
- ELOPIN is temperature stable -40°C to +150°C

Relay series SID

Press-in ELOPIN - Features



Picture: © ELESTA GmbH 2021

ELOPIN Connections

- Highly effective
- Cost-effective
- Easy handling
- For small and large series
- Stress-free for board and components
- Resource-saving
- Energy-saving



Picture: © ELESTA GmbH 2021

Relay series SID

Mounting ELOPIN - Press-in - What must be observed?

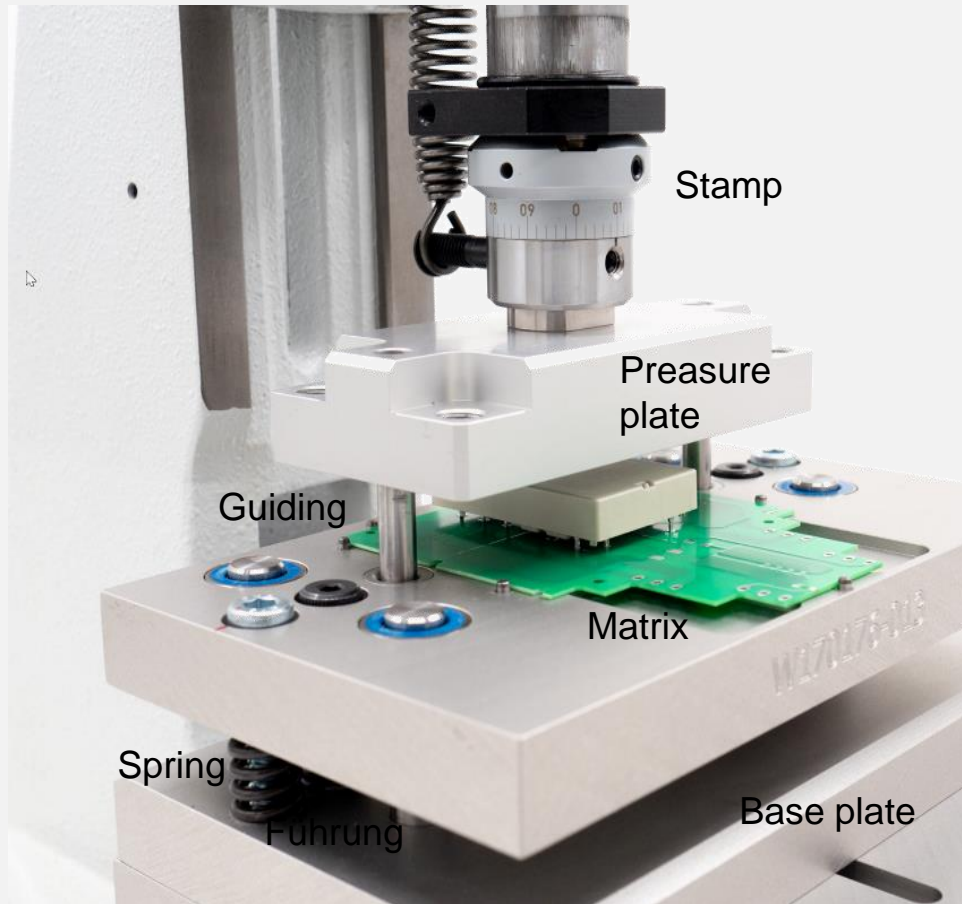

Picture: © ELESTA GmbH 2021

Please note:

- Forming plate / punch for plane force transmission
- Guided die with recess or pins for positional fixing of the blank
- Spring-loaded die or base plate for pressure force compensation and compensation of position tolerances during press-fitting

Relay series SID

Functional safety - Achievable safety level

The safety levels to be achieved depend on the architecture of the respective control of the safety relay! The following information indicates the safety levels that can be achieved with correct integration.

Relays with forcibly guided contacts are basic components and do not represent a safety component, e.g., in the sense of the Machinery Directive.

Relays of the SID series can in principle be used for the realization of 2-channel safety controls.

The two independent contact sets are driven by a magnetic circuit with a relay coil and two independently acting armatures. For use in 2-channel safety control systems, the relay coil (relay drive) must usually be monitored on a 2-channel basis.

The achievable safety levels are:

- According to ISO / EN 13849-1 PL "e" Cat. 4
- According to IEC / EN 62061 SIL cl3

Relay series SID

Functional safety - 2-channel control

Example of 2-channel control of double armature relay SID 4-pole

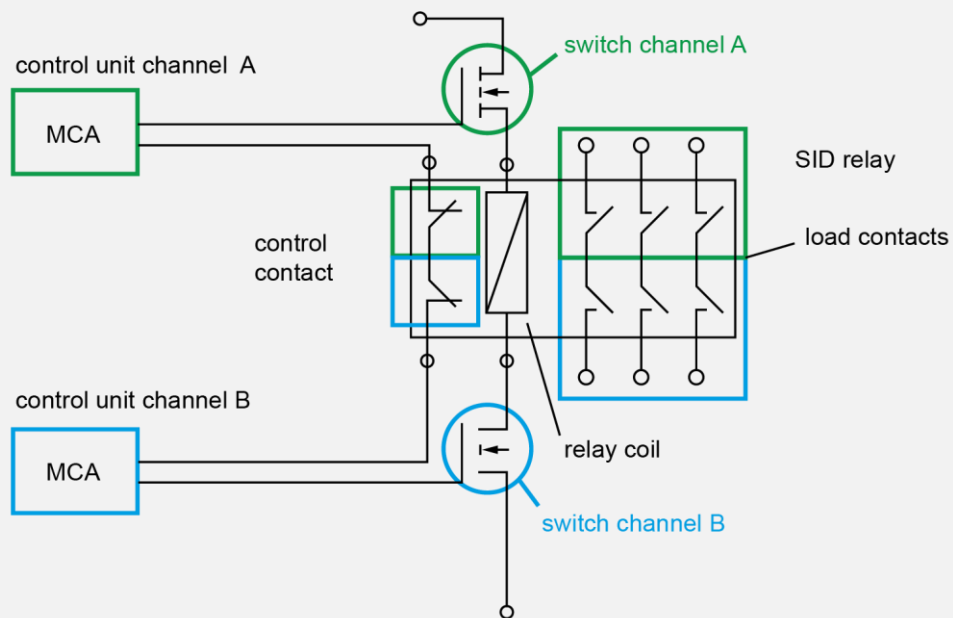

Picture: © ELESTA GmbH 2021

- Two-channel control via channel A and channel B
- The control takes place via the common coil
- The armatures attract individually
- It is not defined which of the armatures pulls in or drops out first
- The pick-up delay or drop-out delay between armature A and armature B is not defined
- The coil control can be checked per channel
- The contact sets behave independently of each other Type A according to IEC 61810-3
- In case of opening failure of a contact from contact set A signals to channel A and channel B remains undisturbed (exclusion of common cause faults)

Relay series SID

Summary

Space requirement / weight

- Weight 2 x SIF 4-pole ~ 40 g
- Weight 1 x SID 4-pole ~ 33.6 g
- Weight reduction 6.4 g
- **16% Weight reduction**
- Area requirement 2 x SIF 4-pole with mounting distance ~ 2452 mm²
- Area requirement 1 x SID 4-pole with mounting distance ~ 1908 mm²
- Area saving ~ 544 mm²
- **22% area reduction!**

1 SID relay can replace 2 conventional relays, energy efficient, resource saving, higher reliability, lower cost

Energy saving

- Coil power per SIF 4-pole ~ 700 mW
- Holding power per SIF 4-pole ~ 210 mW
- Coil power at 2 SIF 4-pole ~ 1400 mW
- Coil power at 1 SID 4-pole ~ 820 mW
- **Saving coil power 580 mW (41%)**
- Holding power per SIF 4-pole ~ 210 mW
- Holding power with 2 SIF 4-pole ~ 420 mW
- Holding power with 1 SID 4-pole ~ 250 mW
- **Saving holding power 170 mW (41%)**

Board layout

- Reduction of the number of holes from 20 to 10
- **Savings of 50% of the drilling**
- Additional placement area of 360 mm² for SMD components up to approx. 3 mm height under the SID 4-pole
- Less layout effort
- Higher design reliability
- **Lower board costs**
- **Solderless assembly with ELOPIN Press-Fit technology**

Public Relations / Marketing



Jürgen Steinhäuser
Head of Sales and Marketing
j.Steinhaeuser@elest-gmbh.com



Lars John
Marketing Communication
l.john@elesta-gmbh.com

ELESTA GmbH
Heuteilstrasse 18
CH 7310 Bad Ragaz
Phone: +49 81 30354-00
Email: admin@elesta-gmbh.com
Web-page: www.elesta-gmbh.com

[Landing page SID4 relays](#)

Downloads:

[Press release SID4](#)

[Press release ELESTA GmbH](#)

We ask for a notification in case of
publication to the above address.

Thanks a lot!